



**Installation Instructions**



[www.tesla-electronics.eu](http://www.tesla-electronics.eu)



Dear customer,

Thank you for purchasing a proven Tesla brand product. Please read this manual carefully before using for the first time. He will be a good guide for you when getting to know your new device. We wish Box Tesla to be a pleasant companion for you. The data and tips used in this manual may be subject to future changes and improvements and are valid for the release of its first version, as of Jul 2022.

Thank you for your understanding.



Read this manual carefully before use. The technical specifications and operating procedures in this manual are subject to change without notice. If you have any questions during the period of use, contact the manufacturer.

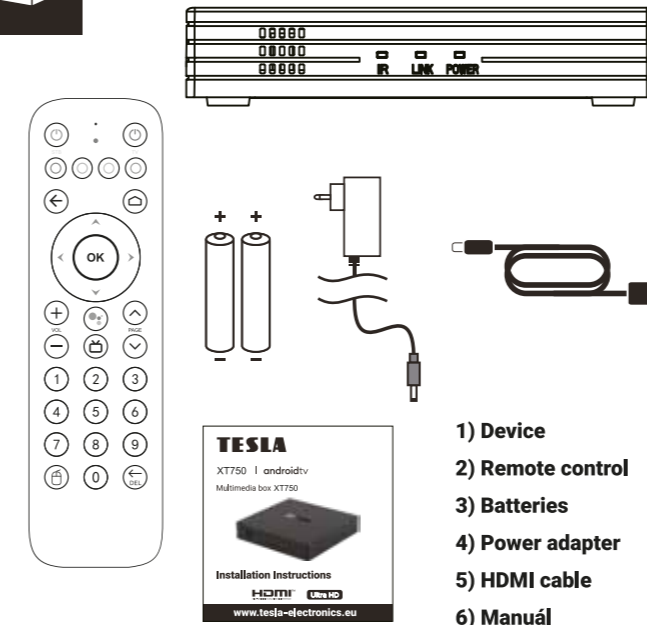
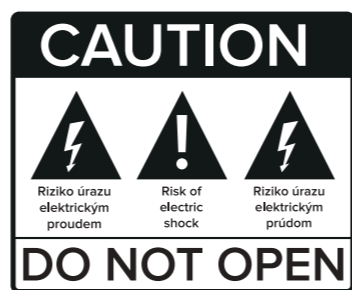

**Remote Guide**

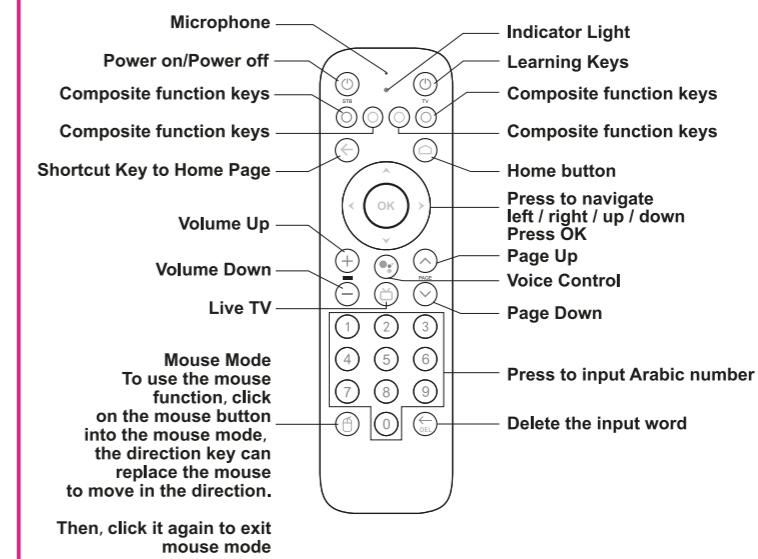

Connect the AC adapter. Connect to the TV with the supplied HDMI cable. Connect the antenna cable with the DVB-T2 signal to the RF-IN connector.

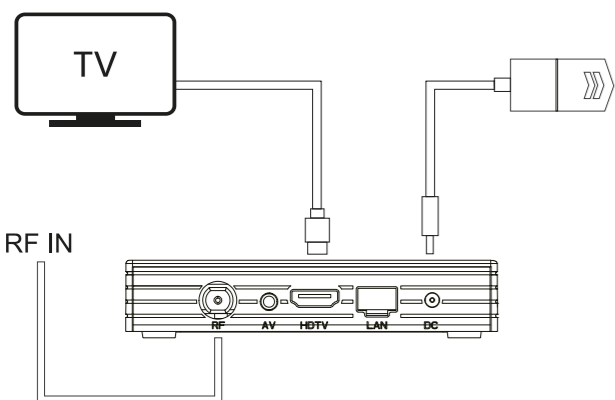

Connect the box to the network. Using either the LAN connector or via WiFi connection (802.11b/g/n/ac; 2.4/5 GHz)

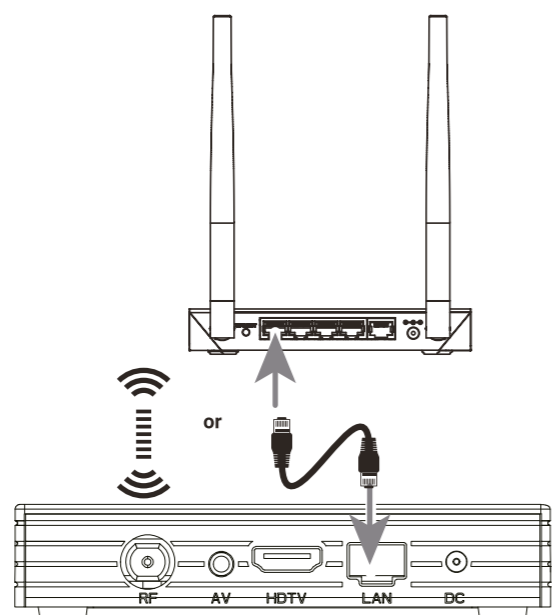

Now pair the controller with the device. The procedure is very simple. Press the buttons on the controller at the same time "VOL-" and "OK" at the same time and hold them for about 5 seconds. Successful pairing will be confirmed on your TV screen.

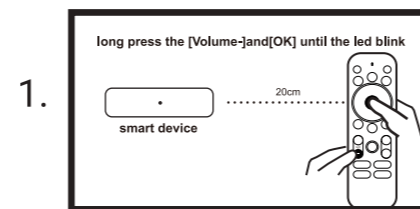

In the next step, you choose the language in which the box will be to communicate. In the scrolling menu, select and confirm "OK".

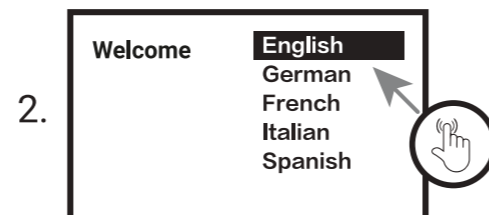

In the next step, you can set up the box using your mobile phone and transfer most important settings (WiFi, etc.) as well as compatible applications automatically. Of course, it is possible to skip this step and make the settings manually.

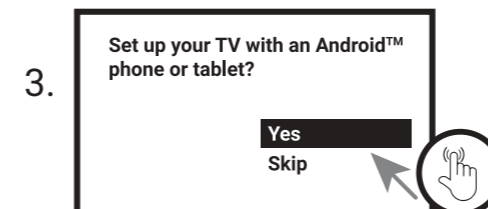

On this screen you can view, read and then confirm the Terms and Conditions.

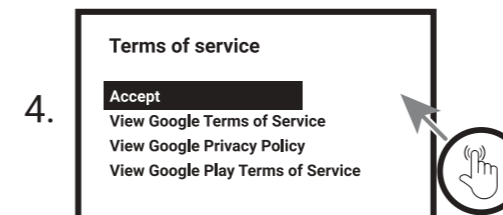

You can enable the device location service to improve the environment. You can adjust these permissions at any time in Settings.

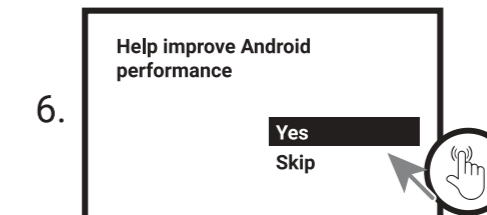
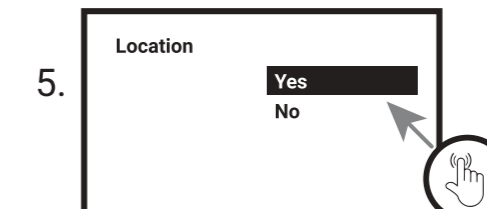

Press the Google Assistant button on your remote to talk to Google.

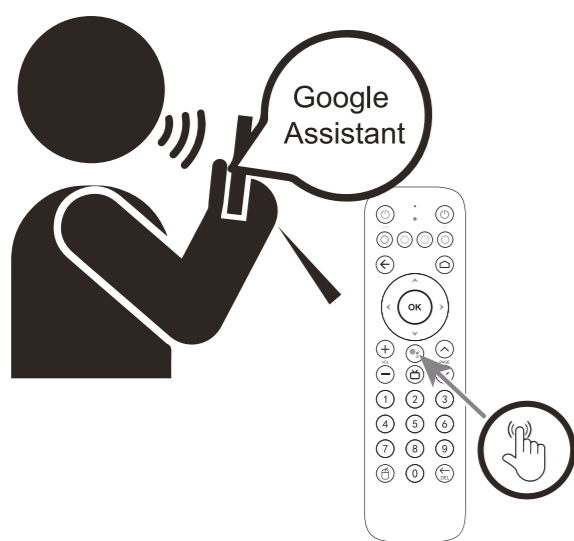

Simplify your entertainment experience with Android TV, by signing into your Google account.

**Download of Apps**

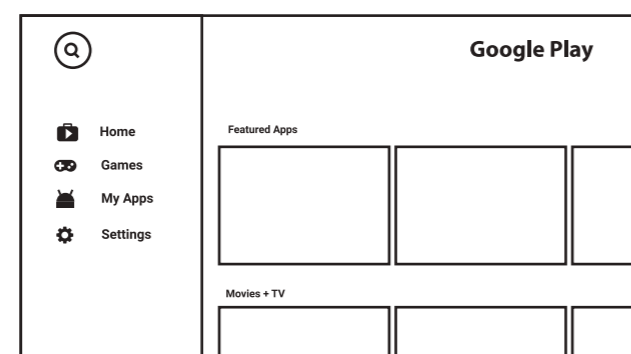

Screen settings: You can adjust the screen zoom so that the screen shows the best status.  
Resolution settings: The machine defaults to automatic. You can manually adjust to the best display status.  
Date & time settings: Set your GMT time, and time display format. (Note: The system display time is synchronized with the network time after the network connection is successful).  
Uninstall APPS: You can uninstall unwanted APKs to keep your system in top condition.  
Factory reset: Be carefully to do this. All the data will be cleared after factory date reset.  
Android TV makes it easier to get more from your TV. Choose from 400,000+ movies and shows from across streaming services. Ask Google to control your TV, get recommendations of what to watch, dim the lights, and more with your voice. Cast photos, videos, and music from smart devices to your TV with Chromecast built-in™.

\* Subscriptions may be required for certain content providers.  
\* Casting optimized for selected services only. Streaming quality for other content might vary. Supported operating systems and devices: Android TM 2.3 and higher, iOS 7 and higher, Windows 7 and higher, Mac OS 10.7 and higher and Chrome OS (version 38 or higher).

There are 3 kinds of live TV channel sources:  
1. Digital TV(DVB-T/T2/C)  
2. Streaming TV(M3U8)  
3. Get more sources (Browse apps that offer live channels from Google Play Store)

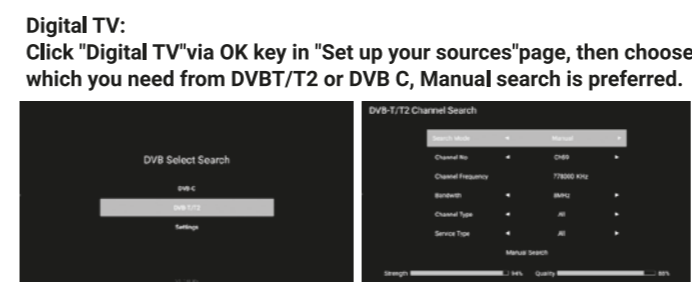

Digital TV: Click "Digital TV" via OK key in "Set up your sources" page, then choose which you need from DVB/T2 or DVB C, Manual search is preferred.

Techniques for using DVB:  
1. Press OK Button in RCU can check channel options when play program.  
2. Press Left Button in RCU can show channel list when play program.

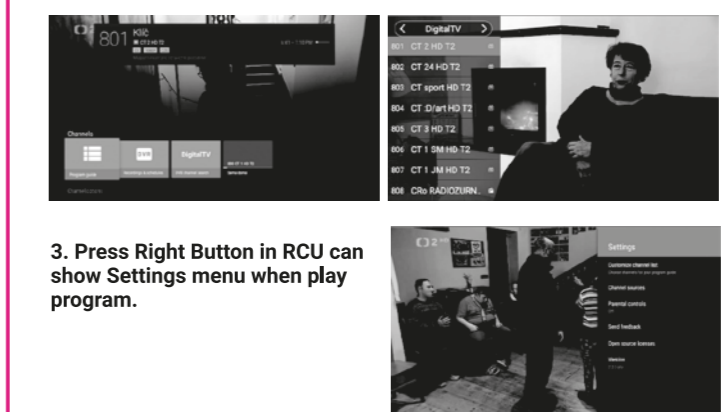

3. Press Right Button in RCU can show Settings menu when play program.

The "RED, GREEN, YELLOW, BLUE" Button means "PVR Record, EPG, Multi-Audio, Subtitle" when play Digital TV program



Streaming TV: Press Right Button during Digital TV play program to open Settings menu, choose "Channel sources", it'll jump to "Set up your sources" page after clicking "Channel sources", choose "Streaming TV" and press OK Button.

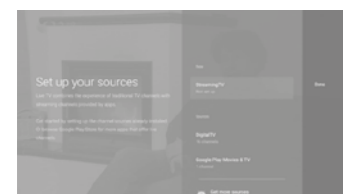

Notice: Streaming TV only supports importing external storage .m3u/.m3u8 files, so you need to read the device file permissions. When a prompt box pops up, please select "Allow".

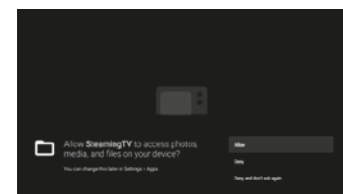

Prepare the .m3u/.m3u8 files and copy them to the root directory of the external storage, connect the external storage to the device, Streaming TV will get the .m3u/.m3u8 files from the external storage, check the required m3u files and click IMPORT to wait for the data to be imported.

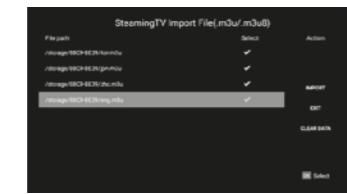

Get more sources Select "Get more sources", it'll be redirected to Google Play Store which lists different recommended VoD apps according to different regions, such as "Pluto TV, Haystack News, etc.". Installing the corresponding APK will import the related programs of it in the Live TV list.

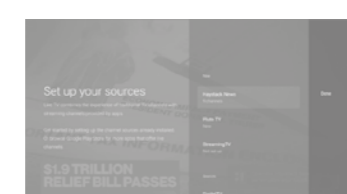

**Tips**

- Keep a minimum of 10cm clearance around the device, do not cover newspapers or other items.
- The equipment must not be exposed to water droplets or water splashes. Objects such as vases filled with liquids must not be placed on the machine.
- Keep the product away from moisture, exposure, high temperatures, etc, away from magnetic objects.
- Avoid scratching the case and the interface, and prevent damage due to falling, throwing or strong impact.
- Use a dedicated power adapter to prevent damage to important components on the motherboard due to excessive current.
- Please do not attempt to disassemble this product yourself. The repair work is only for authorized personnel of the company.
- The battery must not be exposed to some conditions like sunlight, fire, or similar overheating environment.

serial number \_\_\_\_\_ date of sale \_\_\_\_\_

\_\_\_\_\_

date of sale \_\_\_\_\_

**Warranty conditions**

- 1. Warranty period**  
The manufacturer provides a warranty for this product for a period of 24 months from the date of purchase of the product by the consumer. The warranty period is extended by the time during which the product was under warranty repair or could not be used during the warranty period if the nature of the defect prevented its use. The warranty only covers defects caused by a manufacturing error or material defect!
- 2. Warranty card**  
Free warranty service is provided only if you present proof of purchase of the product (receipt) and a correctly completed warranty card – it must include the serial number, date of sale and stamp of the store (assembly companies).

**3. Repairs during the warranty and post-warranty period**  
Warranty service must be claimed from the organization where the product was purchased or from the assembly company that performed the installation.

**4. Scope of warranty**  
The warranty is void if the defect is caused by mechanical damage (except for damage during transport), misuse, inattention, unavoidable event (natural disaster), if the product was connected to a supply voltage other than that specified in the technical specification, and also in case of modifications or repairs performed outside the distributor's service. Nor can the warranty be invoked where the consumer requires modification or adaptation to extend the functionality of the product (or a system composed of several components) compared to the standard design.

**Registration of warranty repairs**

\_\_\_\_\_

Date of notification \_\_\_\_\_

\_\_\_\_\_

Date of implementation \_\_\_\_\_

\_\_\_\_\_

Mounting no. sheet/comment \_\_\_\_\_

\_\_\_\_\_

Signature \_\_\_\_\_